

# DP-60-50

H 855  
D 600  
L 600

## TECHNICAL DATA

<b>Installation</b> Plug-in	<b>External dimensions (LxDxH)</b> 600 x 600 x 855 mm
<b>Temperature</b> +4 / +8°C	<b>Capacity (gross/net)</b> 143 / 64 L
<b>Refrigerant</b> R600a	<b>Weight</b> 70 KG
<b>Refrigeration</b> Ventilated	<b>Energy class</b> D
<b>Compressor</b> NEK6170Y	<b>Energy efficiency index</b> 36,5
<b>Defrost</b> Automatic	<b>Annual energy consumption</b> 2869,34 kWh/A
<b>Climate class</b> 3	<b>Operating conditions</b> 25°C / 60% RH
<b>Glass type</b> Double glass	<b>Frigorific input</b> 410W
<b>Opening system</b> Rear sliding double door	<b>Electrical input</b> 230W
<b>Lighting</b> Double LED 4000K x shelf	<b>Power supply</b> 230V / 50Hz
<b>Configuration</b> -2 shelves (380 x 380) -Mechanical control panel	<b>Openings (Rear/Front)</b> Yes / No

### 3D

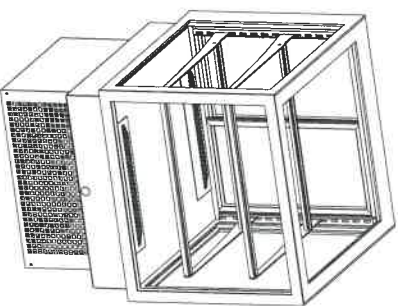

### GENERAL SIZES

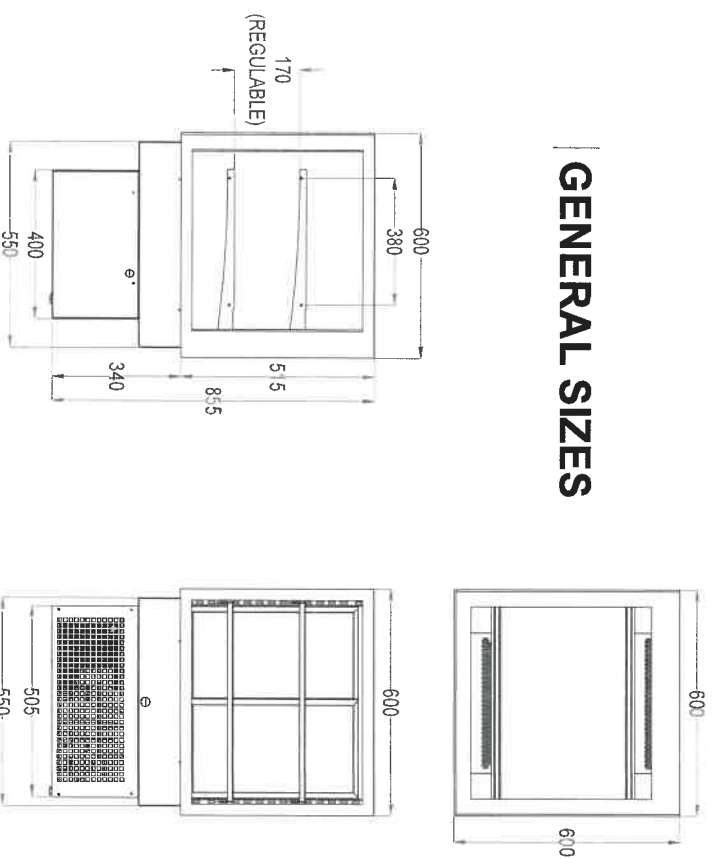

### GOOD PRACTICES

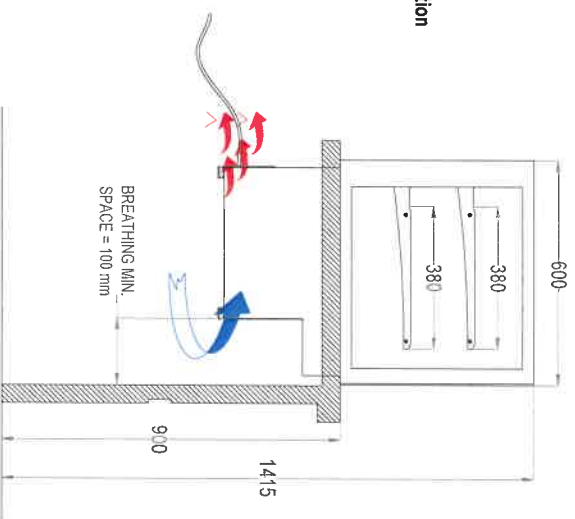

### ELECTRIC DIAGRAM

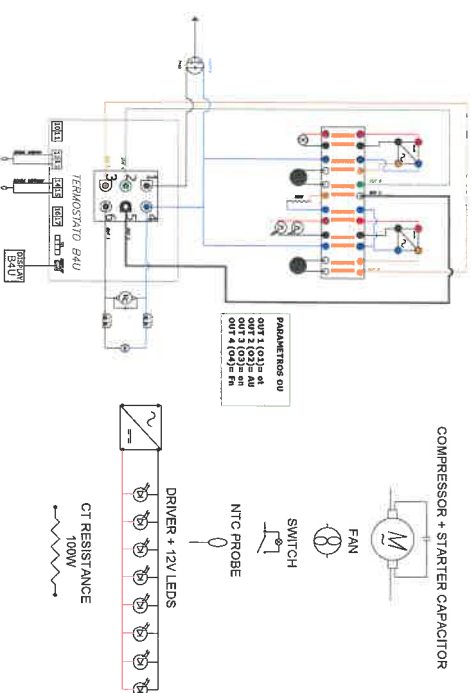

PROPIEDADES				GRUPO FRIGORIFICO				SUMINISTRO				CONTROL				ACCESORIOS		ILUMINACIÓN	
KG NETO	KG BRUTO	LITROS	RÉGIMEN	P.FRIGORIFICA(10°)	COMPRESOR	REFRIGERANTE	CONDENSACIÓN	EVAPORACIÓN	DESCARGHE	TENSIÓN	FRECUENCIA	POTENCIA	TIPO	MODELO	N° ESTANTES	COLOR	DOBLE LED		
DP-60-50	65KG	70KG	145LT	+4°+8°C	410W	NEK6170V	NEK6170V	R600a	VENTILADA	FORZADA	AUTO.	230V	50Hz	230W	DIGITAL	B4U	2(980X360)	4000K	SI

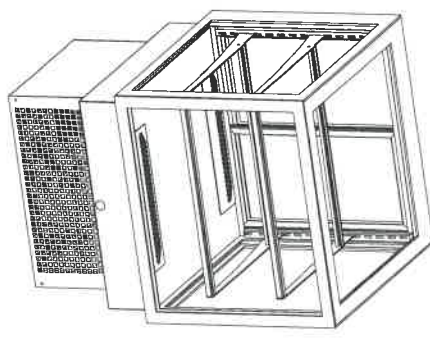
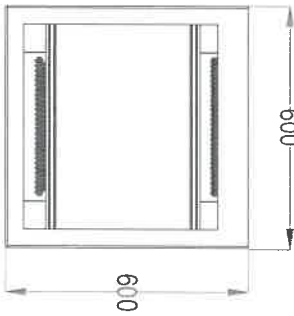
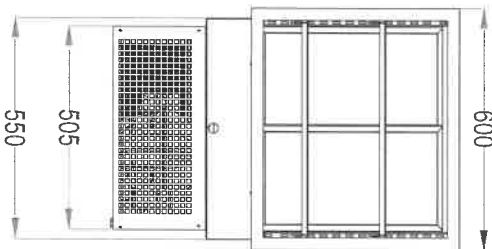
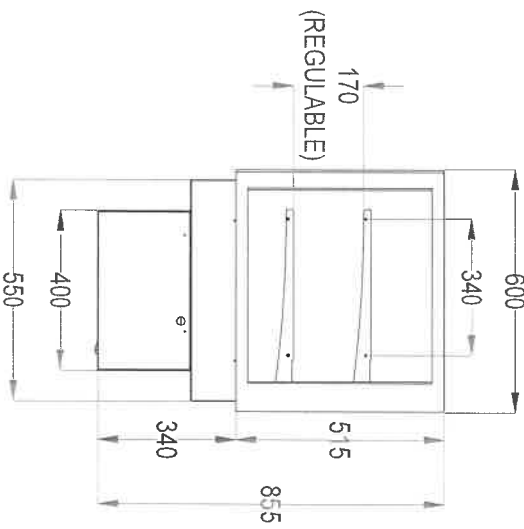

NOTAS		D.ORIGINAL		FECHA		REVISION		FECHA	
		MSC	09-04-2019	PSC				10-07-2023	

ESCALA S:1 CAD: A3

DP-60-50