

Variante B (flächenbündiger Einbau - flush-mount installation)

- ◊ Modul Spule auf Generator als kompakte Einheit - inductor on the generator as compact unit

- ◊ getrennt Spule und Generator getrennt - inductor and generator are separate
 Spule auf Spulenträger - inductor on plate for induction
 Generator in seperatem Anschlußfach - generator in a separate case
 Kabellänge variabel bestellbar - cable length to order variable

	NAME	DATUM	SIG.	DATUM	SIG.	INDEX	ÄNDERUNG
GEZEICHNET							
GEPROBT							
GENEHMIGT							
							BENENNUNG:
							BI2EG7_B
Berner-Kochsysteme GmbH & Co.KG Sudetenstr.5 D-87471 Durach www.induktion.de							ZEICHNUNGSNR. BI2EG7_B
							MASSSTAB: 1:5
							A3
BLATT 1 VON 3							

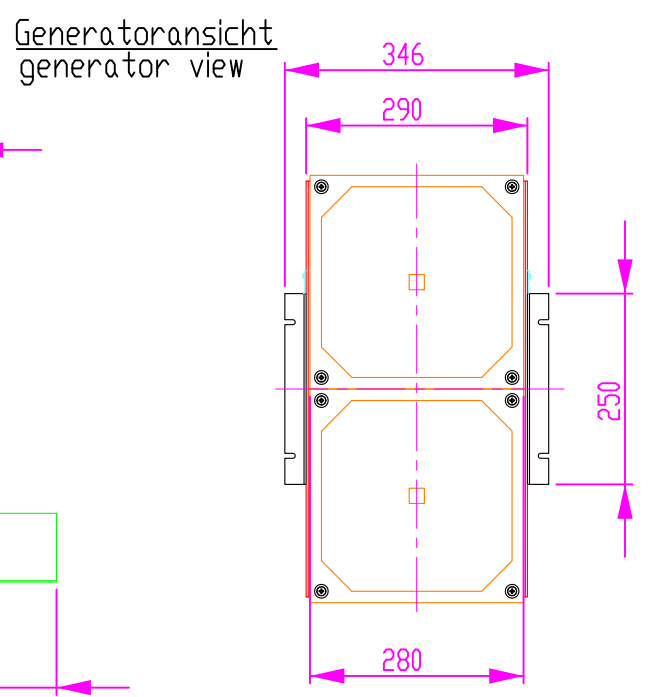
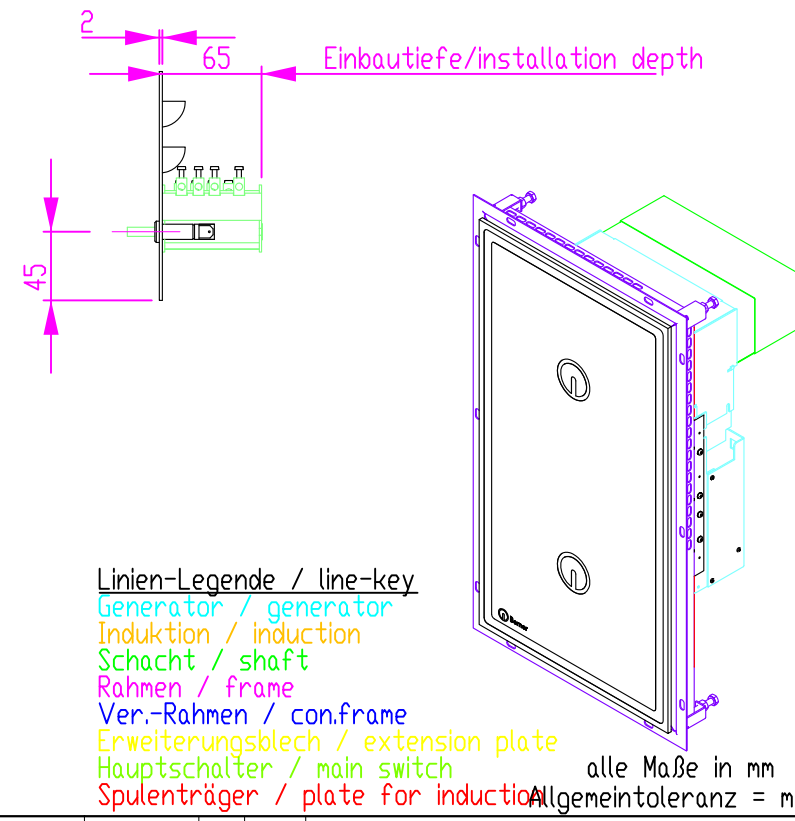
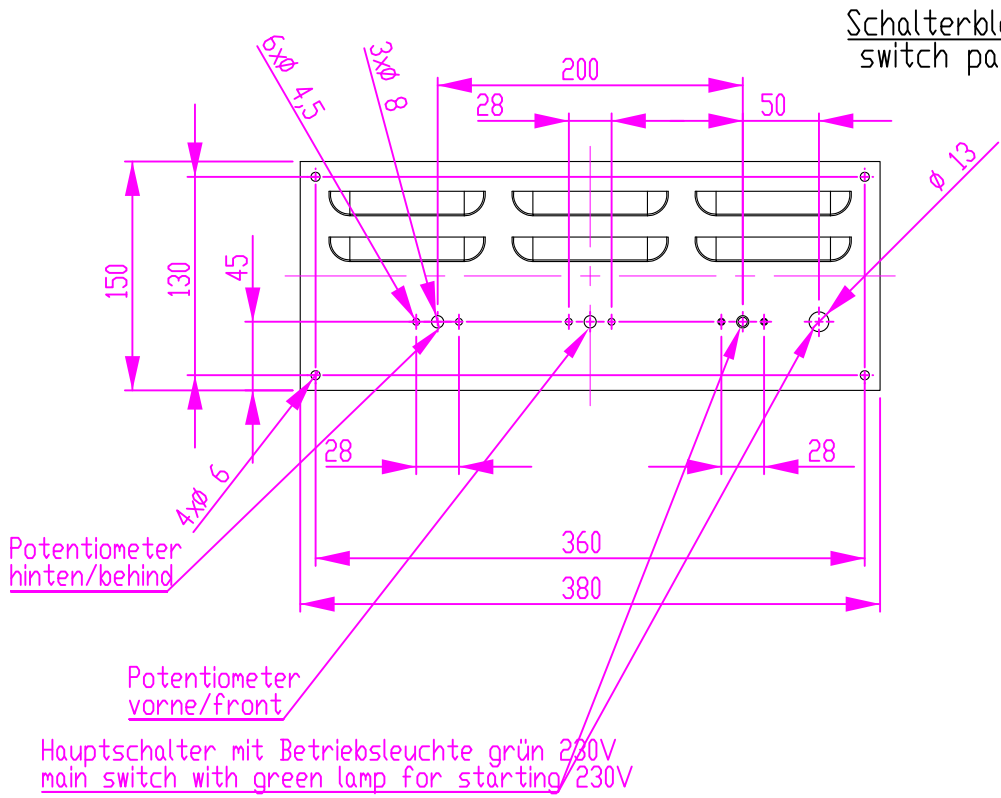
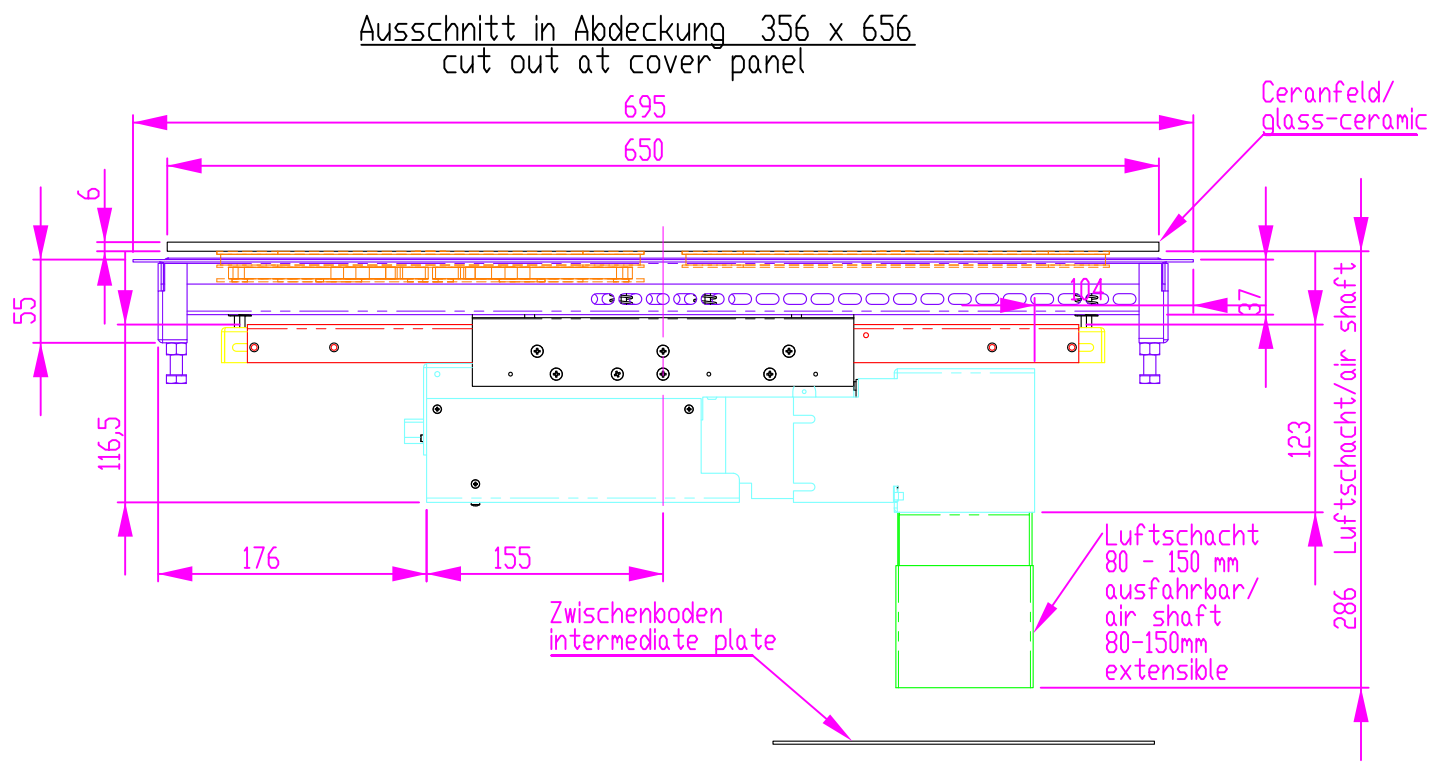
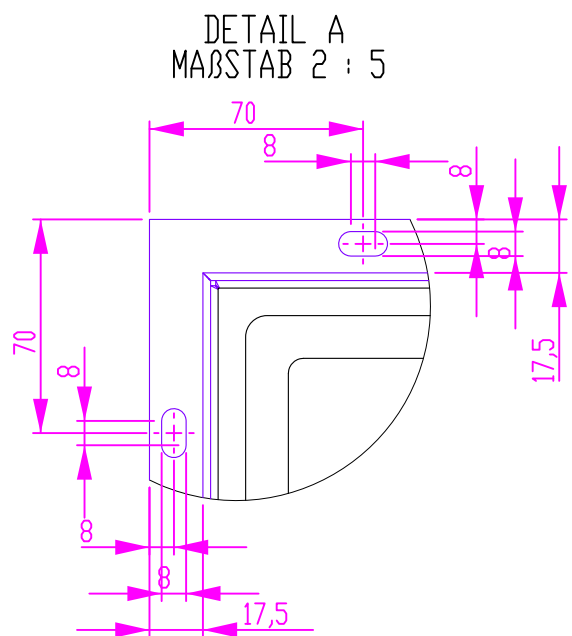
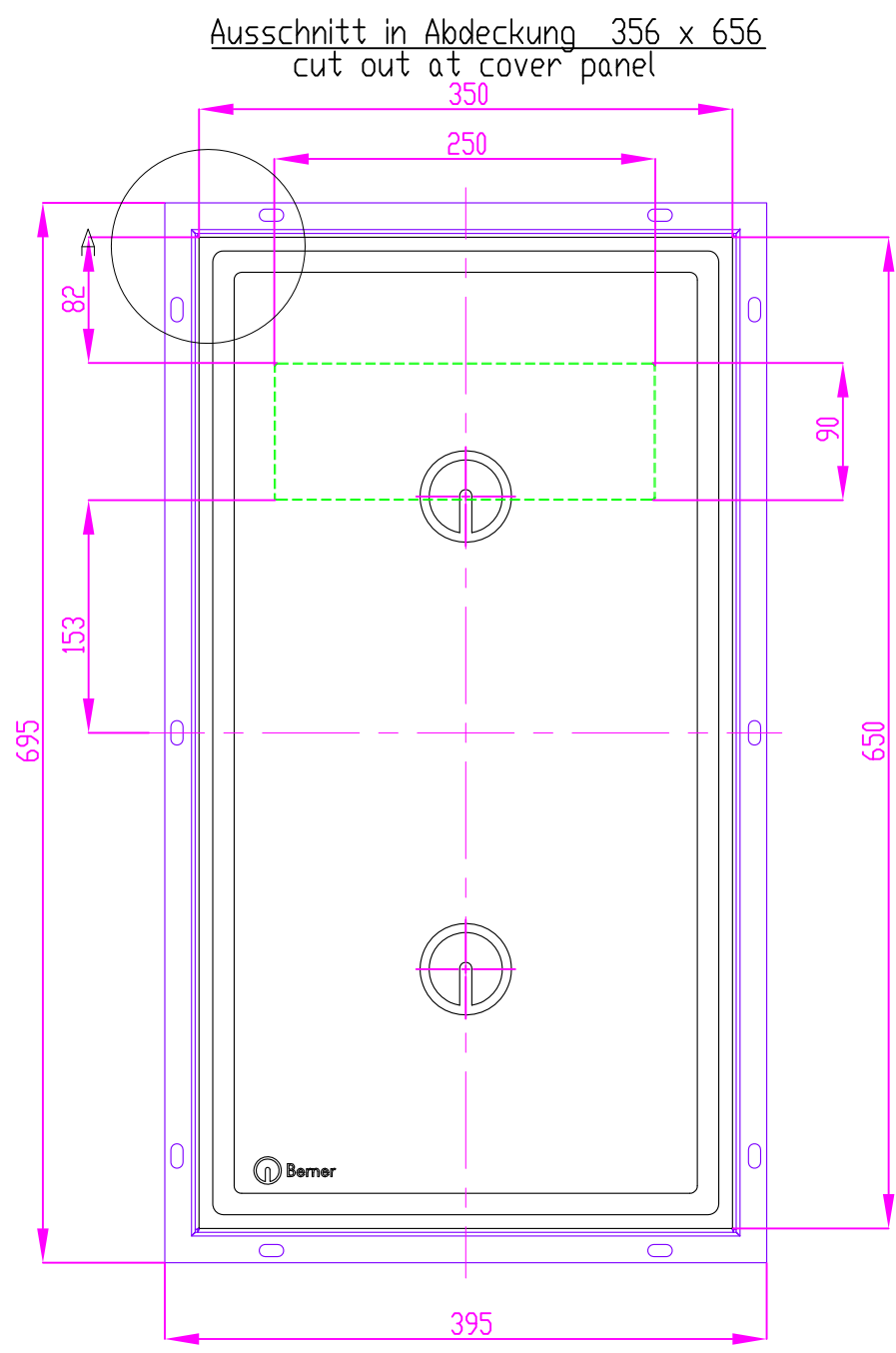

NAME	DATUM	SIG.	DATUM	SIG.	INDEX	ÄNDERUNG
GEZEICHNET Adolf	23.09.2013	MA	23.09.2013	MA	a	
GEPROFT					b	
GENEHMIGT					c	
					d	

BENENNUNG:
Variante_B flächenbündig Modul
version B flush-mount modular unit

ZEICHNUNGSNR. B12EG7_B

Berner-Kochsysteme GmbH & Co.KG
Sudetenstr.5 D-87471 Durach
www.induktion.de

MASSSTAB: 1:5

BLATT 2 VON 3

A3

1 2 3 4 5 6 7 8 9 10 11

Ausschnitt in Abdeckung 356 x 656
cut out at cover panel

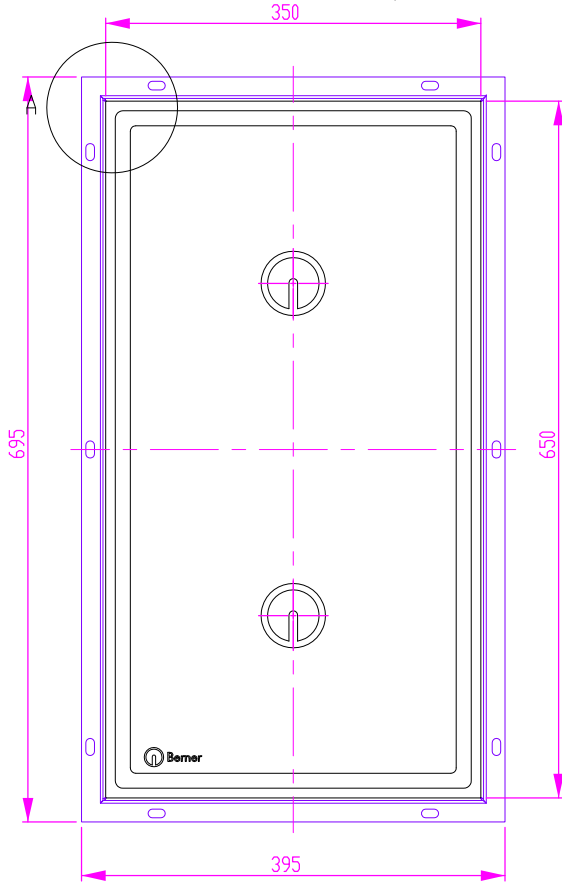

DETAIL A
MAßSTAB 2 : 5

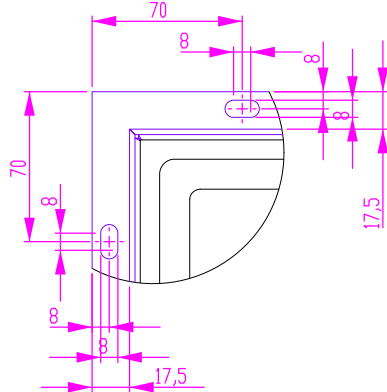

Ausschnitt in Abdeckung 356 x 656
cut out at cover panel

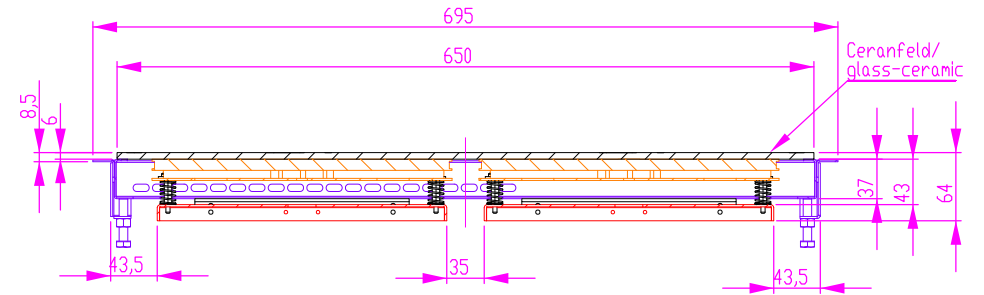

Schalterblende (optional lieferbar)
switch panel - optional available

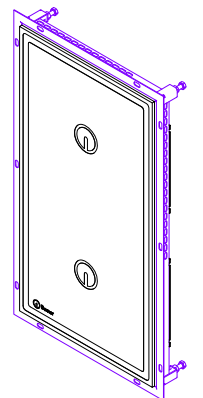
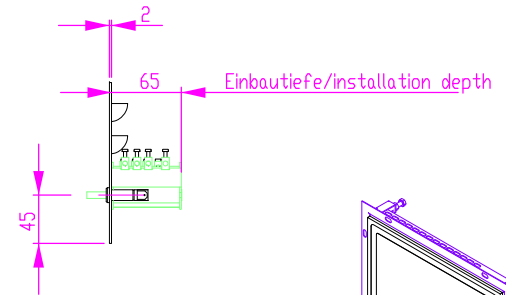
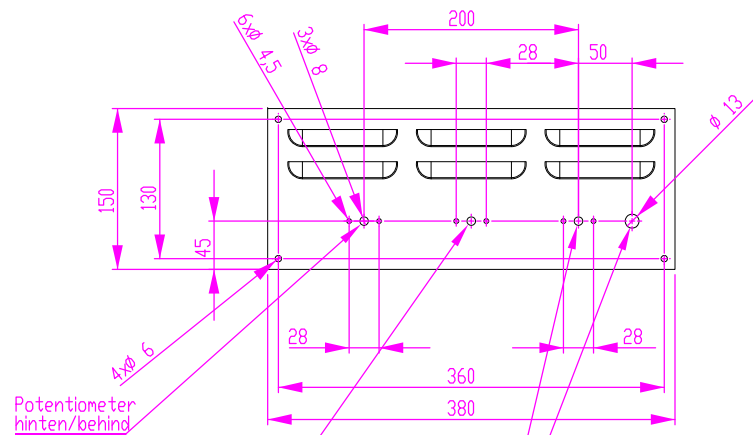

Generatoransicht
generator view

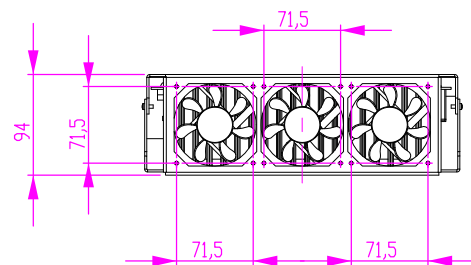
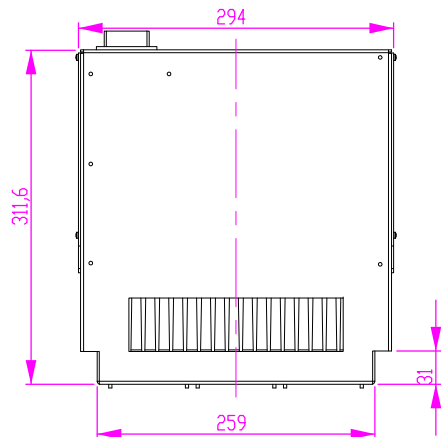

Linien-Legende / line-key

- generator / generator
- Induktion / induction
- Schacht / shaft
- Rahmen / frame
- Ver.-Rahmen / con.frame
- Erweiterungsblech / extension plate
- Hauptschalter / main switch
- Spulenträger / plate for induction

alle Maße in mm
Allgemeintoleranz = m

NAME	DATUM	SIG.	DATUM	SIG.	INDEX	ÄNDERUNG
GEZEICHNET Adolf	23.09.2013	MA	23.09.2013	MA	a	
GEPRÜFT					b	
GENEHMIGT					c	
					d	

BENENNUNG:
Variante_B flächenbündig getrennt
version B flush-mount separated

Berner-Kochsysteme GmbH & Co.KG
Sudetenstr.5 D-87471 Durach
www.induktion.de

ZEICHNUNGSNR. BI2EG7_B MASSSTAB: 1:5

A
B
C
D
E
F
G
H
I
J